

## The glass truss bridge

Snijder, Ate; Nijse, Rob; Louter, Christian

**Publication date**

2018

**Document Version**

Final published version

**Published in**

Heron

**Citation (APA)**

Snijder, A., Nijse, R., & Louter, C. (2018). The glass truss bridge. *Heron*, 63(1/2), 139-157. Article 7. <http://heronjournal.nl/63-12/7.pdf>

**Important note**

To cite this publication, please use the final published version (if applicable). Please check the document version above.

**Copyright**

Other than for strictly personal use, it is not permitted to download, forward or distribute the text or part of it, without the consent of the author(s) and/or copyright holder(s), unless the work is under an open content license such as Creative Commons.

**Takedown policy**

Please contact us and provide details if you believe this document breaches copyrights. We will remove access to the work immediately and investigate your claim.

# The glass truss bridge

Ate Snijder, Rob Nijse, Christian Louter

Delft University of Technology, the Netherlands, a.h.snijder@tudelft.nl

A Glass Truss Bridge has been constructed on the Green Village on the campus of Delft University of Technology (TU Delft) by the Glass & Transparency Research group (faculties of Architecture and CiTG). The bridge has been fitted with as many glass components as was structurally feasible, showcasing the group's research into the structural application of glass in the built environment. The diagonals in the truss are glass bundle struts and the nodes of the truss are cast glass components. The lenticular truss will serve as a temporary bridge. Because of the experimental nature of the truss, with its unusual and novel applications of structural glass, a number of demonstrative proof loadings were performed to ease concerns about the safety of the structure. The glass bundles have been proof-loaded to twice their maximum expected load just prior to their installation in the structure. The whole bridge, once installed, has then been proof-loaded for several critical load combinations (static and dynamic) just after installation. During the proof-loading the strains in the glass diagonals have been measured. These lie well within the acceptable limits.

In the paper the structural design of the bridge, in particular the glass node connector and the glass bundle diagonals will be explained. Then the proof-loading of the bridge will be described and the results of the proof-loading are presented and discussed.<sup>1</sup>

*Keywords: Glass bundles, glass connections, bridge, live load test*

## 1 Project description

For a 14-meter, heavily loaded span, an efficient structural shape is a steel truss in a lenticular form: depth (lever) in the middle, shear force resistance at the supports. As an indication for the depth; 1 to 10-15 ratio of the span was used and 1.20 meter was chosen. As an upper chord, a steel section HEA 120 was selected for resistance against secondary bending between the nodes of the truss. For the lower chord, a steel strip was chosen, since a large tension force can be resisted by this element.

---

<sup>1</sup> This paper is based on an earlier publication by the authors [Snijder et al. 2018].

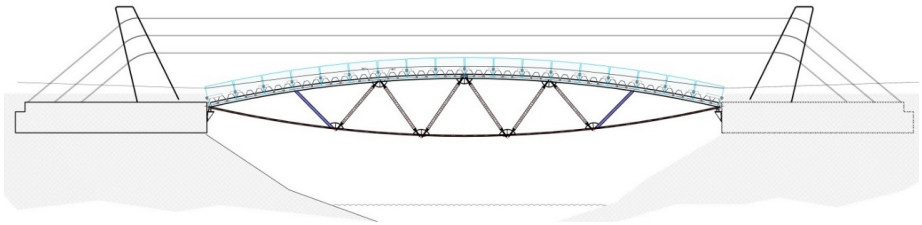

*Figure 1: Drawing of the glass truss bridge in elevation. Note that the left-most and right-most diagonals are steel.*

To emphasize the fact that each part of the Green Village has to be innovative it was decided to make the diagonals and node connectors out of glass. Two choices were made to guarantee the structural safety of these glass components. The first choice is making not one glass massive strut but a bundle of small massive glass rods; failure of one or more rods does not immediately lead to collapse: The total cross sectional area of the bundles is such that when one glass bar should unexpectedly fail, the remaining cross sectional area is still sufficient to take the force in the strut.

The second choice is to put in the center of the bundle a steel rod. Glass can resist high compressive stress and steel can resist high tensile stress. By combining these materials



*Figure 2: The Glass Truss Bridge. Note that the most left and most right diagonals are of steel.*  
*photo by Frank 'Graphdude' Auperle.*

and pre-stressing the bundle, a capacity for high compressive and tensile forces is created. This is a very useful property since an asymmetric live load on the bridge will result in a change of diagonal forces from compression to tension or vice versa. This method ensures structurally safe glass diagonals for the lenticular truss. The glass rods are bonded with UV hardening adhesive. To integrate the steel bar in our glass bundle a hollow star-shaped extruded glass rod was positioned in the center of the bundle. In the opening of the glass star the steel rod was placed.

It was decided to pre-stress the steel bar and thus put a permanent compression load on the glass bars. The pre-stress force was chosen to be identical to the maximum possible tensile force in a diagonal. So, in service, the glass will never be loaded in tension; a stress situation unfavorable for the material.

The most interesting, and challenging, detail of this bridge is the joint of the two glass diagonals and the upper- or the lower chord of the lenticular truss. First starting point was that all center lines should pass through one point in a connecting detail to avoid moments. Second starting point was that the diagonals can be either in compression or under tension, depending on the load case on the bridge, so that the connection should be able to transfer both compressive and tensile force. Third starting point was that the detail should be as transparent (= glass) as possible.

Semi-circular steel strips were bolted to the steel sections of the upper and lower chord of the truss. In the spaces inside the semi-circles waterjet cut glass blocks were placed. In this

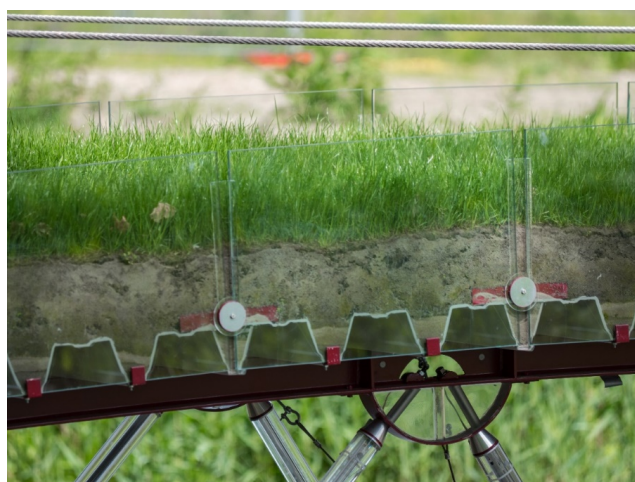
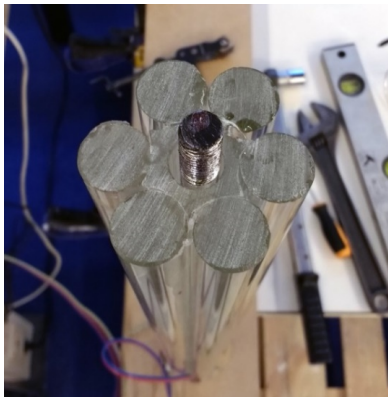

*Figure 3: Deck and connector node of the Glass Truss Bridge. Photo by Frank 'Graphdude' Auperle*

way compression forces in the diagonals simply press against the semi-circular steel strip and the glass blocks inside the semi-circle, while tension forces in the diagonals are transported by the inner steel bar inside the glass bundle diagonal, and also through a hole in the glass block, and is then connected with a steel bolt to the web of the HEA profile.

## 2 Design and construction of the glass bundle diagonals

*'For every structural application it holds that the component should be able to withstand the lunatic with the hammer'*, is the mantra of the glass engineer. Cracking, even crushing of part of the component is allowed, but must not lead to its complete collapse. The goal is ductile behavior, not brittle. Also, according to the Eurocodes, a loadbearing structure must be robust; a component may fail without causing progressive collapse. All these principles apply to the glass diagonals. The concept for the glass bundle column was first conceptualized by Rob Nijse (Nijse, 2003) and further developed by Faidra Oikonomopoulou. Further information can be found in their paper listed in the references (Oikonomopoulou et al, 2017)



bundle of 6 x 22 mm diameter glass rods, bonded with DELO around star shaped hollow profile

12 mm diameter steel rod  
S355, chromed

3 mm of air between glass and steel rod

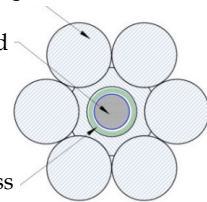
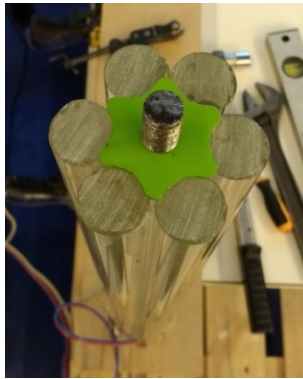

Figure 4 and 5: Cross-section of the bundles

*'The Lunatic with the hammer'* can break one, two, maybe three glass rods, but wiping out the complete bundle would require too much time and effort. In the structural calculations the scenario with one diagonal missing has been checked, and collapse does not occur, although deformation (vertical sag in the middle of the span) increases dramatically. The failed diagonal is assumed to have zero compressive strength but still retains 100% of its tensile capacity, since the steel tendon will remain intact, even as the glass has been

crushed. Only the removal of the diagonal next to the support is problematic: the shear next to the support results in very large deformation. This is why, next to the supports, the diagonals are steel square hollow sections.



*Figure 6: steel pre-tension rod and PLA centering ring*

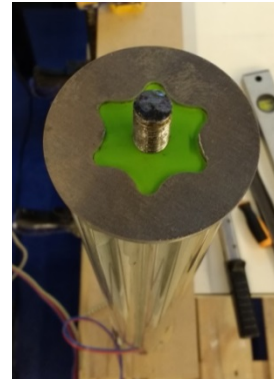

*Figure 7: Soft aluminium cap to avoid peak stresses*

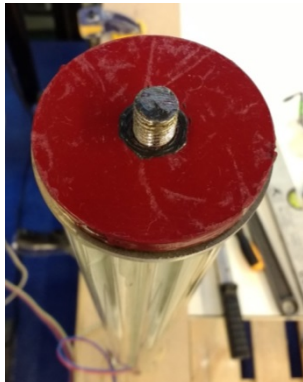

*Figure 8: Steel ring to spread load*

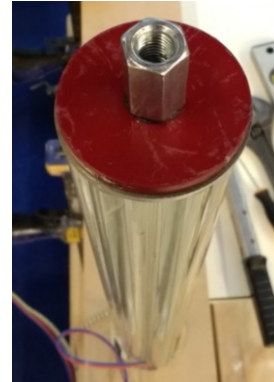

*Figure 9: extension nut to apply pre-stress*

Students from the minor 'Bend and Break' (3<sup>rd</sup> year Civil Engineering students) build structural components (in timber, concrete, steel and masonry) and subsequently load them until failure. This to teach the students that constructing is a profession which determines to a large extent the ultimate strength of a glass structure. To these students the assignment was given to make the glass bundle columns to be used in the bridge. See table 1 for results of the proof loading of these columns.



Twelve columns were produced and tested. The load during the test was twice the maximum expected load in the bridge, in accordance with (ASTM E997-15). This load was maintained for ten minutes. A few of the bundles showed signs of partial failure, chipping or cracks and were discarded. These failures probably occurred due to incomplete bonding of the bundles by the glue or uneven lengths of the bundles. This shows that for the fabrication of glass bundles, the quality of workmanship determines to a large extent the spread in strength values that can be assumed.



Figure 10. Hydraulic piston



Figure 11. Force gauge



Figure 12. ball hinge

Each of the columns that were tested were fitted with strain gauges on three sides. Figure 17 indicates their placement on the bundle. The strain gauges were read out during the proof loading and showed that the strain was nearly evenly distributed over the cross section of the bundle: minimal bending occurred during the test. The graph in figure 15 shows typical stress - force relation observed in all the satisfactorily proof loaded bundles. The stress was computed from the strain with an E modulus of  $63\,000\text{ N/mm}^2$  for the duran glass taken from Schott's technical specification. There is some plastic deformation in the setup. This is most likely the 4 mm soft aluminium cap, see figure 7.



Figure 13: Test setup

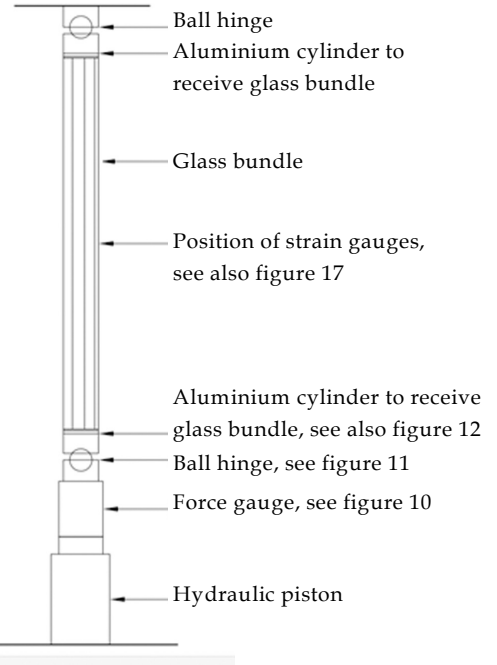

Figure 14: Diagram of the test setup

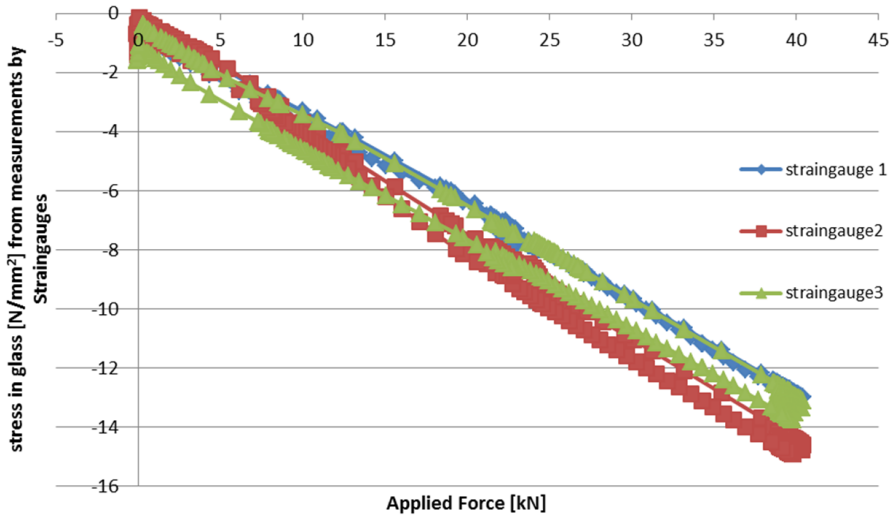

Figure 15: The stress (vertical axis) from strain recorded by three strain gauges plotted against force (horizontal axis) recorded by the force gauge



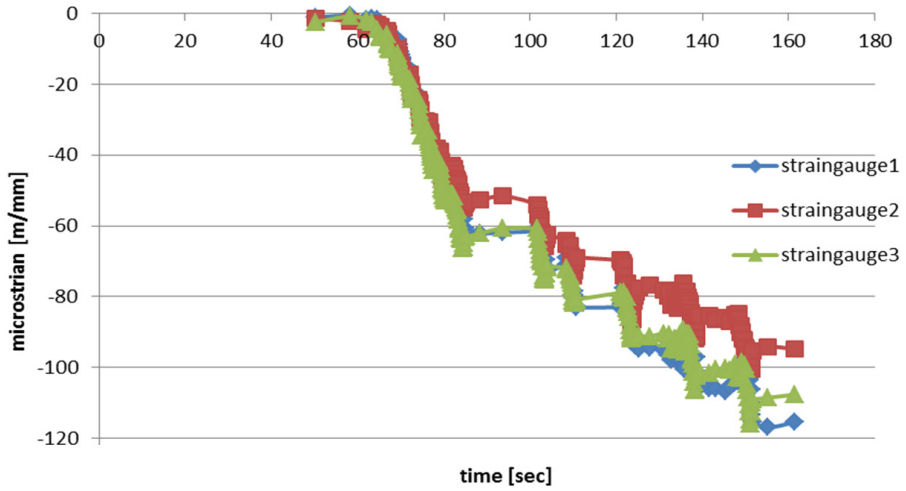

Figure 16: The strain (vertical axis) recorded by three strain gauges plotted against force (horizontal axis) recorded by the force gauge during manual application of pre-stress to the bundle. Note that the turns of the wrench are clearly visible in the recorded data.

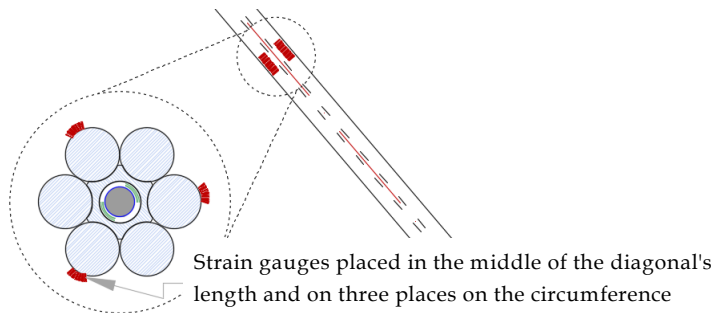

Figure 17 : The strain (vertical axis) recorded by three strain gauges placed on the bundle as shown in drawing above.

Table 1: Result of the proof loading of individual glass bundles

Length <sup>1</sup>	Max force <sup>2</sup>	Pre-stress force <sup>3</sup>	Measured force <sup>4</sup>	Mean stress <sup>5</sup>
1251 mm	23.7 kN	17.2 kN	47.4 kN	25.3 N/mm <sup>2</sup>
1339	19.5	18.8	39.0	22.7
1408	19.5	16.6	39.0	21.8

<sup>1</sup>Four specimens per length

<sup>2</sup>Maximum compression that was expected according to the model discussed in chapter 4 of this paper

<sup>3</sup> Pre-stress force already applied in specimen

<sup>4</sup> Compressive force in the proof loading measured by a force gauge (excluding prestress)

<sup>5</sup> Mean of the stress in the glass measured by three strain gauges placed as indicated in figure 17

### 3 Details of nodes and supports

To allow the diagonals to take tensile forces without actually introducing tensile stresses in the glass, a steel 12 mm diameter rod is placed in the hollow central channel of the star shaped glass profile. By pre-tensioning the steel rod, a constant compressive stress is introduced in the glass. This central steel rod also solved issues in the design of the connection. A simple extended nut makes the connection between the glass diagonal and the top or bottom chord of the truss (figs 18 and 19). The only downside was the black line visible in the middle of the glass bundle. To avoid this the tendon was coated in reflective chrome, which made the steel virtually invisible in the glass diagonal.

How to connect the top and bottom chords to the diagonals? In the Stevin-II laboratory 3 possibilities have been investigated to transfer a large compressive force into a glass bundle without irregularities or contaminants in the contact area between glass and steel causing premature cracking of the glass. In the paper (Oikonomopoulou et al, 2017) an adhesive connection between the glass and an aluminium cap was tested. During the Bend and Break course lead sheets were tested as intermediate, but their plastic deformation caused the glass bundle to split by being wedged open, which led to premature cracking of the glass at contact. Not all the rods will have exactly the same length. This effect too, will have to be solved in the detailing. The experiments showed that soft aluminum (which was also heated and cooled slowly to remove residual stresses from the material) was best suited as interface at the contact surface between steel and glass.

An aluminum head in the shape of a truncated cone is placed at the ends of the diagonals. The surface area of the truncated end of the cone is as small as the stresses allow. This means the diagonal can still freely rotate around the node, ensuring that the critical buckling length is equal the length of the diagonal and without bending moments that would result from a fixed connection. It was considered to place the ends of two diagonals, that come together at a single node, on as small a steel node possible. However, we wanted to again apply glass to 'lighten' the node. Some studies were done on a completely cast

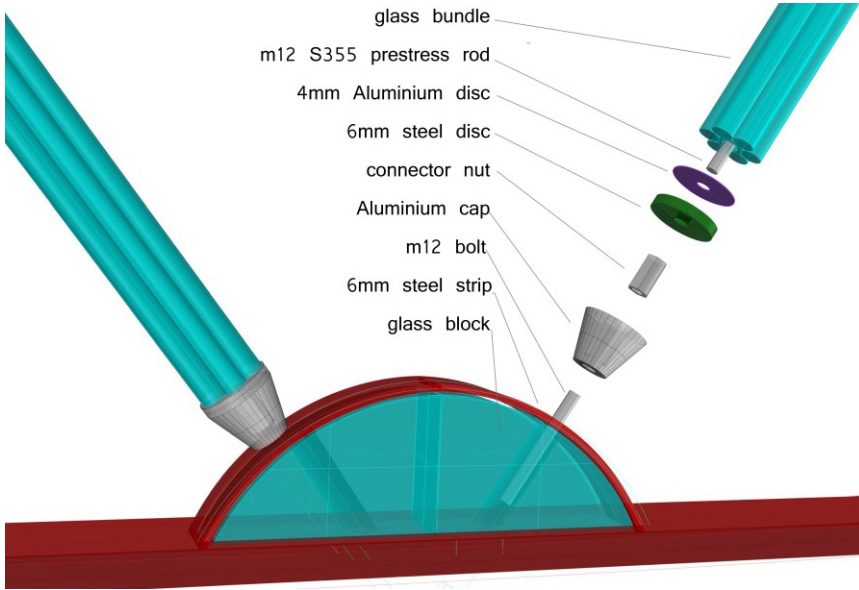

Figure 18: Final solution for the glass diagonal

glass node, but the fast-paced design and construction phase did not allow enough time to properly engineer such an all-glass node. In the end a 6 mm thick steel strip is curved around two waterjet cut glass blocks (left-over from the Crystal houses project in Amsterdam) and bonded with double sided acrylate tape. Here again; the solution works well in compression, but in tension? A truss with diagonals in a 'W' configuration will be subjected to tensile forces as well. By extending the pre-stress tendon in the diagonal with

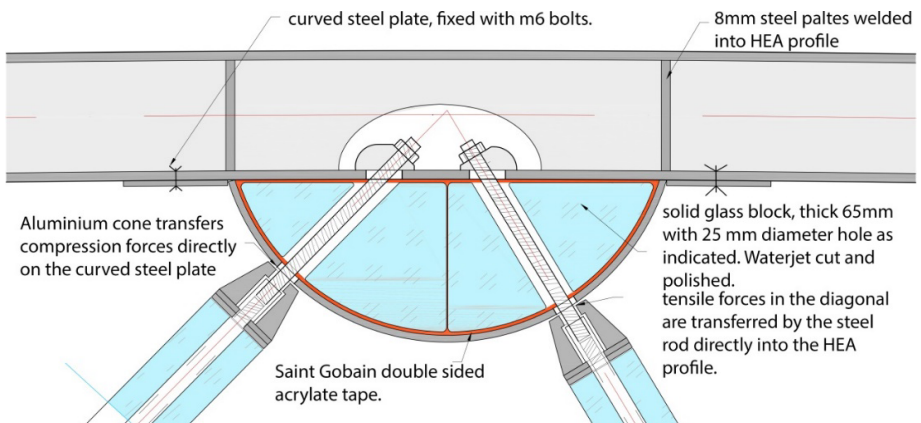

Figure 19: Complete connection detail of diagonal to node S

an extension nut and cutting a hole through the solid glass block, it is possible to connect the diagonal directly to the top and bottom chords of the truss through the steel.

#### 4 Structural analysis

A distributed live load of 5 kN/m<sup>2</sup> or two loads of 80 kN and 40 kN representing an emergency vehicle have been assumed, according to NEN-EN 1991-2. A horizontal load of ten percent of the live load has been assumed to act along the long axis of the bridge. The consequence class for the bridge was CC1 and the reliability class RC1. The bridge is temporary; design life smaller than 10 year.



*Figure 20: Waterjet cutting of the glass blocks for the nodes*



*Figure 21: The node after placement in the truss*

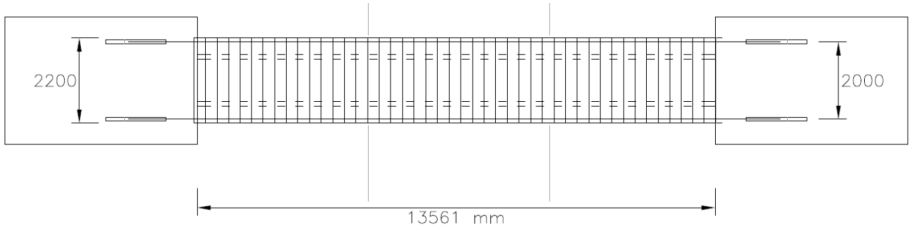

Figure 22: Plan view bridge

The calculation has been done in DIANA finite element analysis using truss elements for the glass diagonals and beam elements for the top and bottom chords of the truss. Four load cases have been checked (Fig. 23 to 26).

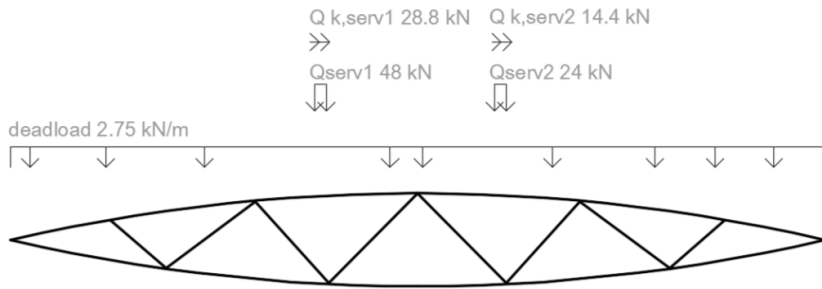

Figure 23: Load case 1, vehicle

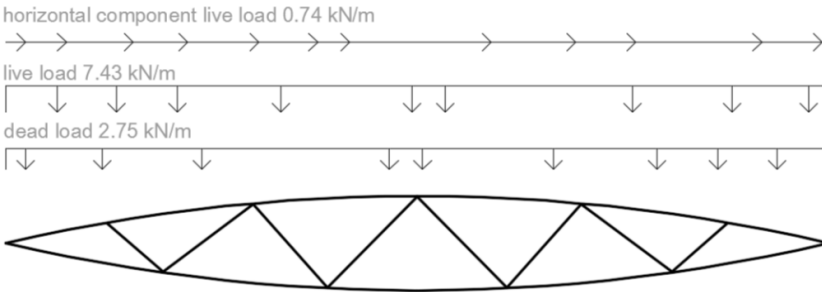

Figure 24: Load case 2, crowd

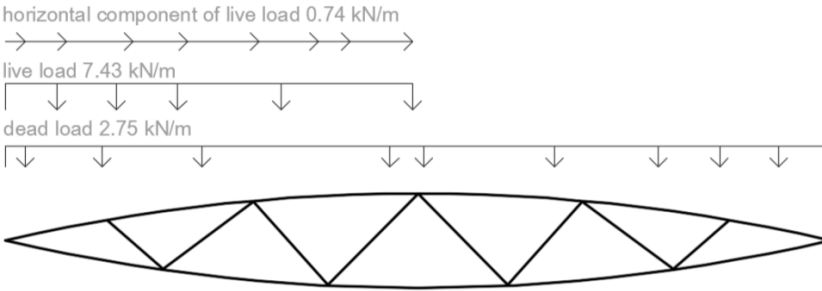

Figure 25: Load case 3, asymmetric load crowd

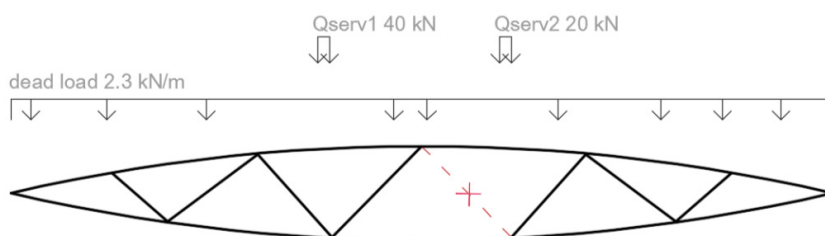

Figure 26: Load case 4, vehicle and one collapsed diagonal

The results of the serviceability limit state are

- Load case 1: max vertical deflection 21.0 mm
- Load case 2: max vertical deflection 25.5 mm
- Load case 3: max vertical deflection 25.6 mm
- Load case 4: max vertical deflection 38.1 mm

The results of the ultimate limit state are shown in table 2. The letters assigned to the glass diagonals is shown in figure 27.

Table 2: Results of static calculation of the Glass Truss Bridge

Glass diagonals	Load case 1	Load case 2	Load case 3	Load case 4
A	-10.4 kN	-2.23 kN	-31.3 kN	-26.3 kN
B	-5.29	-16.9	-11.2	-17.0
C	-7.51	+7.69	-2.88	+3.56
D	-8.49	-18.2	-26.0	X
E	-4.19	+11.1	+13.4	-9.82
F	-11.2	-11.5	-27.8	-31.6
Vert. support reaction left	69.2	57.0	51.4	48
Vert. support reaction right	70.0	31.9	51.1	43.5
Hor. support reaction	10.1	5.11	39.0	0

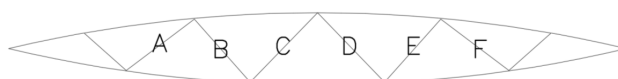

Figure 27: Letters assigned to diagonals



The largest (tension) normal force in the diagonals is 13.4 kN. In response a minimum of 16 kN of prestress was applied to the glass diagonals. If we add up the largest tension force and the prestressing force (conservative approach since compression of the glass will reduce the tensile force in the steel tendon) the result is a maximum tensile force of 29.4 kN. For this a S355 steel rod of 12 mm diameter is used. The utilization of the rod is then  $(29400 / (\pi \cdot 5.18^2)) / 355 = 0.982$ .

For the design strength of the glass 20 MPa has been assumed. The largest compression force is 31.6 kN. When the prestress is simply added (conservative assumption) then the total compression is 47.6 kN. The cross-sectional area of the glass rods is 2552 mm<sup>2</sup>. The utilization of the glass diagonal under compression is:  
 $(47600 / 2552) / 20 = 0.93$ .

*Buckling*

Table 3 shows the largest compression force that can occur in a diagonal. This is highest compressive force value from among the four load cases presented in table 2, with the addition of the pre-stressing force of 16 kN. Euler’s critical buckling force per bundle has been computed and the factor that relates it to its predicted largest compression force.

**5 Realistic proof loading**

In addition to extensive computer modeling, in which the collapse of one of the diagonals has been simulated, and the proof-loading of the individual glass bundles in the Stevin-II laboratory, it was decided to also proof load the entire bridge as constructed in its final configuration. For this, we called in 60 TU Delft students. Thirty from the faculty of Architecture and thirty from the faculty of Civil Engineering. They were the literal live

*Table 3: Euler buckling of the diagonals of the Glass Truss Bridge*

Bundle	Length	Euler’s critical buckling force	Largest compression force	Factor
A	1325 mm	-251 kN	-47.3 kN	5.31
B	1472	-203	-33.0	6.15
C	1543	-185	-23.5	7.87
D	1543	-185	-42.0	4.40
E	1472	-203	-25.8	7.86
F	1325	-251	-47.6	5.27

load and we asked them to perform different static loading configurations and dynamic ones too.

The students were each weighed at the beginning of the test. This resulted in an average mass of 73.5 kg per student. For the various load cases the students have been counted and multiplied by this number to obtain the total load. Then divided by half of the width of the bridge (2 m) and the length of the relevant section of the span to get to the distributed load in kN/m.

Each diagonal has been fitted with three strain gauges, placed on the bundles as shown in figure 17. Using the mean strain,  $E = 63\,000\text{ N/mm}^2$  (value taken from specifications provided by Schott) and  $A = 2551\text{ mm}^2$  the nominal forces in the diagonals were computed.

## 6 Load cases

The test loads are shown in Figure 28 to 31. For Load case 3 only 20 students are on the bridge at one time, corresponding to a weight of  $20 \times 0.735 = 14.7\text{ kN}$ . For load case 4, the marching students were packed more closely together and all 60 were on the bridge at the same time, as can be observed in Figure 30. For Load case 5, 30 students were on the bridge at one time. Corresponding to a weight of  $30 \times 0.735 = 22.05\text{ kN}$ .



Figure 28 : Load case 1, 67 students, approximately 1.81 kN/m



Figure 29: Load case 2, Asymmetric load with 39 students, approximately 2.11 kN/m



*Figure 30: Load case 3, 60 running students, approximately 14.7 kN/m*



*Figure 31: Load case 4, 60 Marching students*



*Figure 32: Load case 5, Dancing students, approximately 22.05 kN*

## 7 Results and discussion

Table 4 shows the measured forces in the diagonals. The most critical loading scenario is Load case 4; the marching students. Two possible explanations:

1. The load is dynamic, each step exerts a larger downward force than just the student's weight because of momentum.
2. This effect is also present in the running and especially the dancing students, Load case 3 and 5. However, in these load cases the students were much further apart and at any time only 20 or 30 students were on the bridge deck. In the case of the marching students they were able to walk in close formation and all 60 were on the bridge.

It makes sense that the highest tension forces occurred in the diagonals during the asymmetric loading. The numerical and analytical study prior to the test already showed that this loading scenario would be most critical for tension.

## 8 Conclusions

In all loading scenarios, even the most critical scenario with the marching students, the utilization of the diagonals was low. The highest compressive force was 3.98 kN. This diagonal has been proof loaded in the lab to 47.4 kN, twice the maximum expected load of 23.7 kN. So we only managed to get to 16.8% of the maximum expected load.

Table 4: Nominal forces in kN in the diagonals for the different loading scenarios

Force [kN]		A	B	C	D	E	F
LC 1 = fully loaded		-2.36	-0.94	-1.39	-0.99	-1.23	-2.21
LC 2 = half loaded		1.59	1.92	-0.21	<b>2.52</b>	-0.92	<b>2.34</b>
LC 3 = running	min	-1.80	-2.04	-1.55	-1.50	-1.40	-2.02
	max	1.06	1.05	1.47	1.05	0.99	0.61
LC 4 = marching	min	-3.42	<b>-2.62</b>	<b>-3.43</b>	<b>-2.66</b>	<b>-2.89</b>	<b>-3.98</b>
	max	<b>1.82</b>	<b>2.52</b>	<b>1.76</b>	2.24	<b>1.65</b>	1.78
LC 5 = dancing	min	<b>-3.95</b>	-2.13	-3.36	-2.02	-2.68	-3.66
	max	0.82	1.82	1.06	1.14	1.07	1.00

Red shows highest tension forces and green shows highest compression forces.

It was physically not possible to create a static live load of 5 kN/m<sup>2</sup>. However, if we consider the load effect of dynamic loading of the marching students on the force in the diagonals and reverse calculate how high a static load would be required to create the same load effect then we get close: approximately 3 kN/m<sup>2</sup>.

The bridge is over engineered, but shows that glass structural elements can safely be applied in the loadbearing structures of buildings and bridges. Over the lifespan of the bridge the Glass and Transparency will continue to make observations and take measurements to monitor the structural performance of the glass components in the bridge.

### *Acknowledgements*

DIMI (Delft Delta's, Infrastructures & Mobility Institute) has sponsored the research and construction of the bridge. The firm ZWATRA transport has sponsored transport of the bridge from the Stevin II lab and placement on site. The Green Village has provided the location for the bridge and the abutments. Hovenier van der Heijden has created the landscaped deck of the bridge at discounted rate. Students from the minor Bend and Break have created the glass diagonals with the help of Kees Baardolf.

## References

- A. Snijder, R. Nijse, C. Louter, 2018. Building and Testing of a Lenticular Truss Bridge with Glass-Bundle Diagonals and Cast Glass Connections. *Challenging Glass 6 Conference Proceedings*. Delft.
- R. Nijse, W. Maas, 2003. *Glass in Structures: Elements, Concepts, Designs*. Birkhauser. Berlin, Germany.
- F. Oikonomopoulou, E.A.M. van den Broek, T. Bristogianni, F.A. Veer, and R. Nijse, 2017. 'Design and experimental testing of the bundled glass column', *Glass Structures & Engineering*, 2: 183-200.
- M. Aurik, A.H. Snijder, C. Noteboom, R. Nijse, C. Louter, 2018. 'Experimental analysis on the glass-interlayer system in glass masonry arches'. *Glass Structures & Engineering*.
- ASTM international. Committee on standards. E997-15 *Standard Test Method for Evaluating Glass Breakage Probability Under the Influence of Uniform Static Loads by Proof Load Testing*, West Conshohocken, PA, USA.
- European Committee for Standardization (CEN). (2004). "Eurocode 1: Actions on structures – Part 1-1: General actions – Thermal actions." EN 1991-1-1, Brussels, Belgium
- Duran; Tubing, rods and capillaries made of Borosilicate glass 3.3. Schott Datasheet. 2016. Mitterteich, Germany. [www.schott.com/tubing](http://www.schott.com/tubing)



